

AULA 2 Desenho Técnico Assistido por Computador

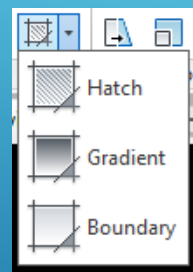

DRAW

AULA 2 Desenho Técnico Assistido por Computador

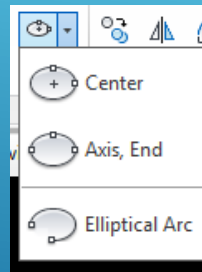
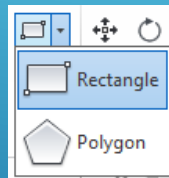
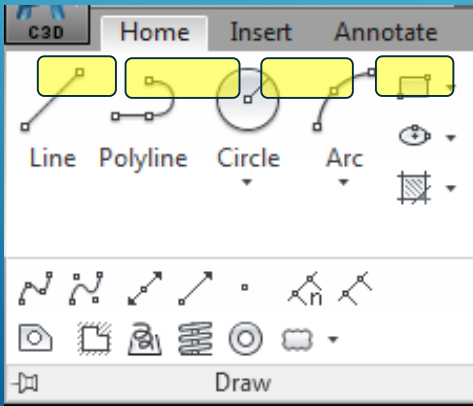
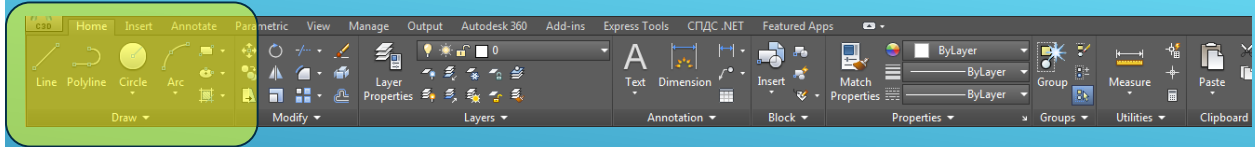

Line
Creates straight line segments

With LINE, you can create a series of contiguous line segments. Each segment is a line object that can be edited separately.

Polyline
Creates a 2D polyline

A 2D polyline is a connected sequence of segments created as a single planar object. You can create straight line segments, arc segments, or a combination of the two.

Rectangle
Creates a rectangular polyline

Creates a rectangular polyline from the specified rectangle parameters (length, width, rotation) and type of corners (fillet, chamfer, or square).

Arc
Creates an arc using three points

Construction Line
Creates a line of infinite length

Lines that extend to infinity, such as xlines, can be used to create construction and reference lines, and for trimming boundaries.

Polygon
Creates an equilateral closed polyline

You can specify the different parameters of the polygon including the number of sides. The difference between the inscribed and circumscribed options is shown.

Ellipse
Creates an ellipse or an elliptical arc

The first two points of the ellipse determine the location and length of the first axis. The third point determines the distance between the center of the ellipse and the end point of the second axis.

Circle
Creates a circle using a center point and a radius

AULA 2 Desenho Técnico Assistido por Computador

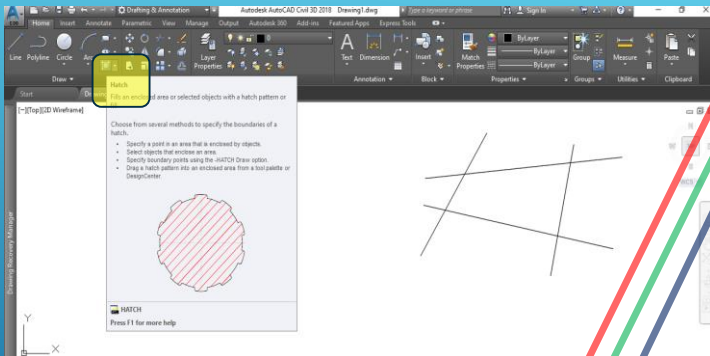

Hatch

Preenchimento contínuo de uma cor

"Degradé" de uma cor

Aplicação de um padrão predefinido no ficheiro acadiso.pat (unidades métricas) ou no ficheiro acad.pat (unidades imperiais)

Padrão de linhas cujos parâmetros são definidos pelo utilizador

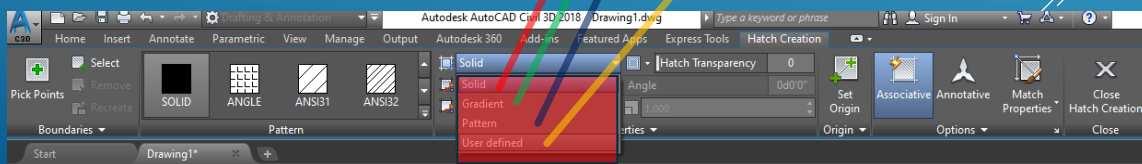

AULA 2 Desenho Técnico Assistido por Computador

1. Seleccionar o padrão da trama a aplicar

2. Definir as propriedades da trama

2.1. Se **Solid**: layer, transparência, cor

2.2. Se **Gradient**: ângulo da direcção do efeito de gradação, 2 cores ou 1 cor e percentagem da transição dessa cor para o preto (0%) ou o branco (100%), em que o valor de 50% corresponde à ausência de gradação

AULA 2 Desenho Técnico Assistido por Computador



2.3. Se **Pattern**: ângulo de rotação, escala do padrão, cor do fundo

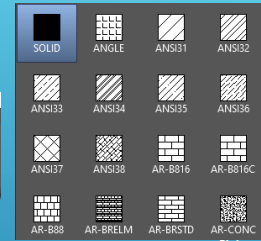
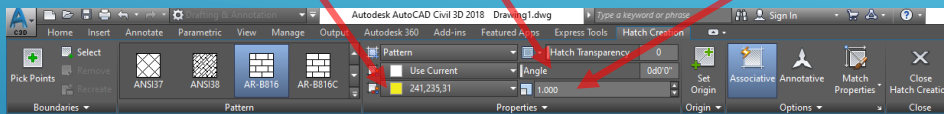

2.4. Se **User Defined**: cor do fundo, espaçamento entre linhas paralelas em unidades do desenho, ângulo de rotação dessas linhas, padrão duplicado ou não (se duplicado o cruzamento é ortogonal)

AULA 2 Desenho Técnico Assistido por Computador



Caso não tenha sido alterado com o comando HPORIGIN, o padrão do tipo Pattern ou User Defined tem como origem o ponto (0,0) do sistema de coordenadas activo.

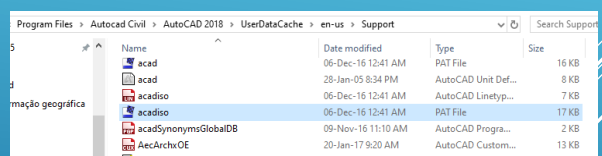
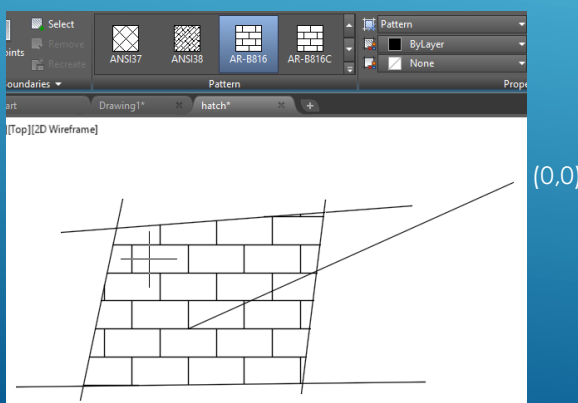

```
*ANSI38,ANSI Aluminum
45. 0. 0. 0. 3.175
135. 0. 0. 6.35. 3.175. 7.9375. -4.7625
*AR-B816, 8x16 block elevation stretcher bond
0. 0. 0. 0. 203.2
90. 0. 0. 203.2. 203.2. 203.2. -203.2
*AR-B816C, 8x16 block elevation stretcher bond with mortar joints
0. 0. 0. 203.2. 203.2. 396.875. -9.525
0. -203.2. 9.525. 203.2. 203.2. 396.875. -9.525
90. 0. 0. 203.2. 203.2. -212.725. 193.675
90. -9.525. 0. 203.2. 203.2. -212.725. 193.675
*AR-B88, 8x8 block elevation stretcher bond
0. 0. 0. 0. 203.2
90. 0. 0. 203.2. 101.6. 203.2. -203.2
```

AULA 2 Desenho Técnico Assistido por Computador



Criação de novos padrões: podem ser guardados nos ficheiros acadiso.pat ou acad.pat ou podem ser guardados em ficheiros próprios, cujo nome coincide com o nome do padrão (esse ficheiro pode conter apenas um padrão), como ilustrado no exemplo seguinte e **deve ser guardado na mesma pasta onde está o ficheiro de desenho**:

***teste.pat**

45, 0, 0, 0, 3.175

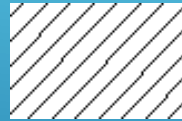

ANSI31

*nome do padrão [, descrição]

ângulo, X-origin, Y-origin, deltaX, deltaY [, traço1, traço2 ...]

em que **ângulo**: ângulo com o eixo X; **X-origin, Y-origin**: a linha definidora do padrão contém este ponto; **deltaX**: utilizado apenas para linhas tracejadas (indica a separação entre traços); **deltaY**: espaçamento entre linhas, medido ortogonalmente às linhas, nas unidades do desenho (sinal positivo=traço, sinal negativo=espaço em branco, 0=ponto)

AULA 2 Desenho Técnico Assistido por Computador



C:\...\teste.pat *

```
*teste
30, 0, 0, 1.25, 1, 1, -1, 1
```

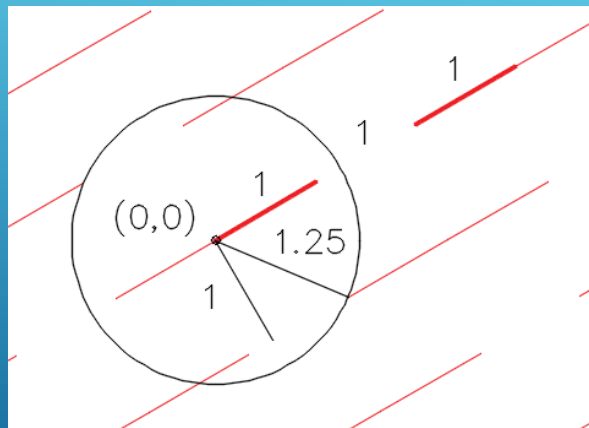

AULA 2 Desenho Técnico Assistido por Computador



Após a 1ª linha, correspondente ao header, sucedem-se as linhas que definem o padrão, cada uma delas dando origem à primeira linha de uma dada família, criada aplicando os deslocamentos em ambas as direcções de forma a gerar uma família infinita de linhas paralelas (cada uma destas linhas do ficheiro .pat pode incluir letras, algarismos e os caracteres especiais hífen (_) e dolar (\$), devendo no entanto começar por uma letra).

Deve incluir-se uma linha em branco após a última linha definidora do padrão pois caso contrário este ultimo padrão não será desenhado.

O processo de hatching consiste na expansão de cada uma das linhas correspondentes ao padrão formando uma família infinita de linhas paralelas. Em seguida verificam-se todos os objectos seleccionados para intersecção com este padrão, tornando-se o padrão ON quando isso acontece.

AULA 2 Desenho Técnico Assistido por Computador



Importação de um ficheiro .pat criado pelo utilizador:

1. Na Ribbon: Home > Hatch
2. Na linha de comando: **settings**
3. **Custom, Custom Pattern**

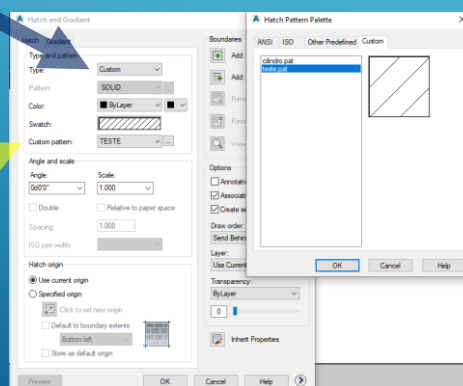
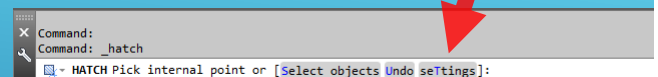

AULA 2 Desenho Técnico Assistido por Computador



O menu *Hatch* contém várias opções:

- **Type**: Selecciona o tipo de padronização (*Predefined, User defined, Custom*).
- **Pattern**: Selecciona o padrão a ser aplicada (ISO, ANSI ou personalizadas).
- **Swatch**: Permite que o padrão seleccionado seja visualizado, abrindo-se uma caixa de diálogo de escolha do padrão.
- **Angle**: Escolhe o ângulo de inclinação do padrão.
- **Scale**: Escolhe a escala a ser aplicada ao padrão. Escalas maiores significam densidades menores e vice-versa.
- **Custom Pattern**: Caso o utilizador deseje gravar um padrão personalizado.
- **Add: Pick Point**: Escolhe um ponto no desenho interior à área a ser padronizada.
- **Add: Select Objects**: Escolhe objectos fechados para serem padronizados.
- **Remove boundaries**: Permite remover “ilhas”, indicando no desenho as áreas fechadas que não se deseja padronizar.
- **View Selection**: Visualiza os objectos seleccionados para padronização.
- **Inherit Properties**: Herdar propriedades de um padrão já realizado (escala, tipo, ângulo, etc.), indicando no desenho qual.
- **Associative**: Associa o padrão às suas fronteiras, permitindo que ela se actualize caso suas fronteiras forem mudadas.

AULA 2 Desenho Técnico Assistido por Computador



Pode acontecer que um dado padrão definido no comando hatch tenha sido construído em unidades imperiais e esteja a ser utilizado num ficheiro de desenho com unidades métricas, de tal forma que o padrão fique demasiado denso, mesmo com um factor de escala pequeno.

O comando `MEASUREMENT=1` corresponde a unidades métricas e `MEASUREMENT=0` corresponde a unidades imperiais: alternar o valor a aplicar com o hatch.

AULA 2 Desenho Técnico Assistido por Computador

O menu *Advanced* contém algumas outras sugestões de padronização:

- **Island Detection Style:** Define o método de detecção de ilhas dentro da área a ser padronizada, como mostra a figura a seguir.

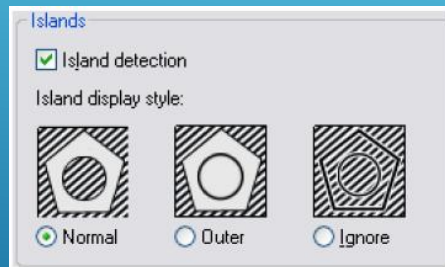

- **Hocht origin:** Permite seleccionar o ponto de origem do padrão.

AULA 2 Desenho Técnico Assistido por Computador

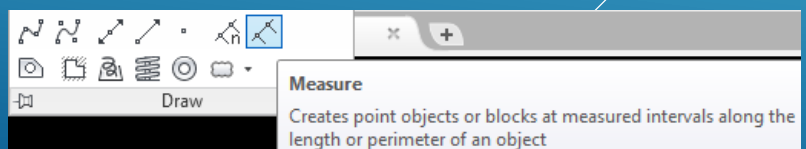
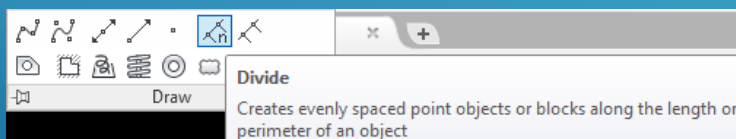
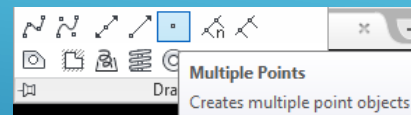
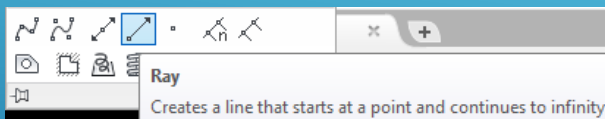
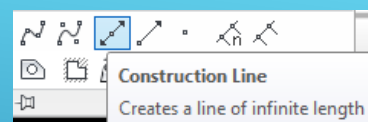
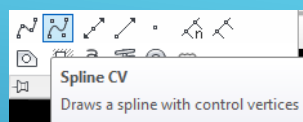
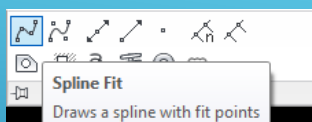

AULA 2 Desenho Técnico Assistido por Computador

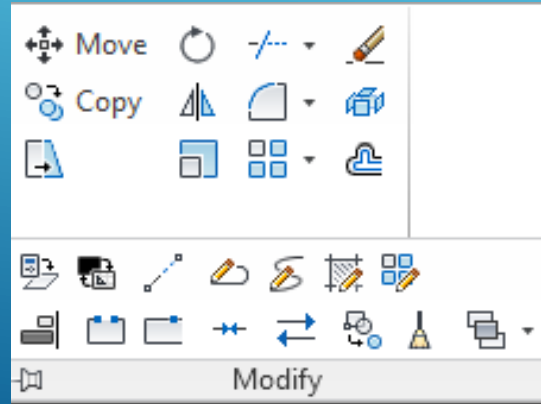
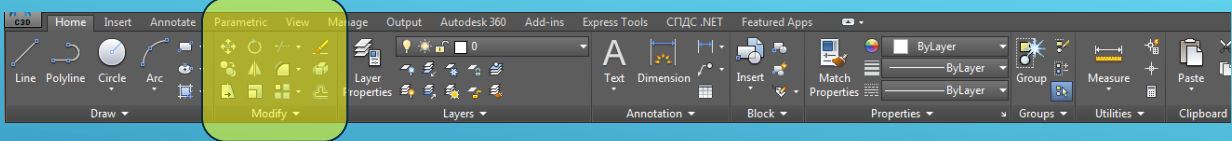

MODIFY

AULA 2 Desenho Técnico Assistido por Computador

Move

Moves objects a specified distance in a specified direction

Use coordinates, grid snaps, object snaps, and other tools to move objects with precision.

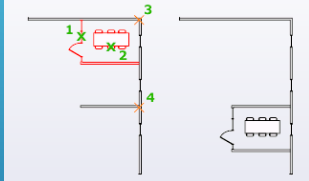

Copy

Copies objects a specified distance in a specified direction

With the COPYMODE system variable, you can control whether multiple copies are created automatically.

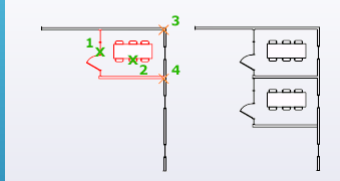

Rotate

Rotates objects around a base point

You can rotate selected objects around a base point to an absolute angle.

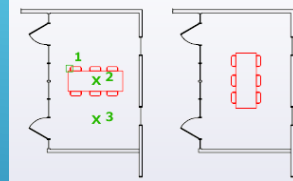

Mirror

Creates a mirrored copy of selected objects

You can create objects that represent half of a drawing, select them, and mirror them across a specified line to create the other half.

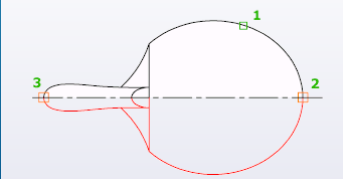

Stretch

Stretches objects crossed by a selection window or polygon

Objects that are partially enclosed by a crossing window are stretched. Objects that are completely enclosed within the crossing window, or that are selected individually, are moved rather than stretched. Some types of objects such as circles, ellipses, and blocks, cannot be stretched.

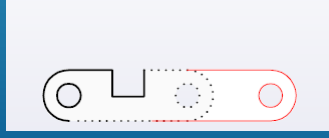

Scale

Enlarges or reduces selected objects, keeping the proportions of the object the same after scaling

To scale an object, specify a base point and a scale factor. The base point acts as the center of the scaling operation and remains stationary. A scale factor greater than 1 enlarges the object. A scale factor between 0 and 1 shrinks the object.

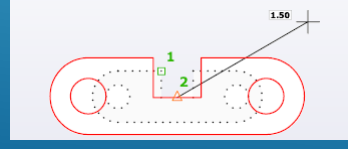

AULA 2 Desenho Técnico Assistido por Computador

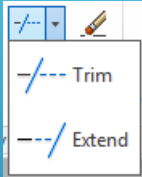

Trim

Trims objects to meet the edges of other objects

To trim objects, select the boundaries. Then press Enter and select the objects that you want to trim. To use all objects as boundaries, press Enter at the first Select Objects prompt.

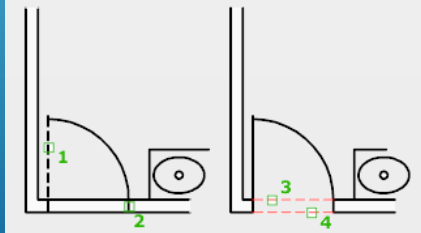

Extend

Extends objects to meet the edges of other objects

To extend objects, first select the boundaries. Then press Enter and select the objects that you want to extend. To use all objects as boundaries, press Enter at the first Select Objects prompt.

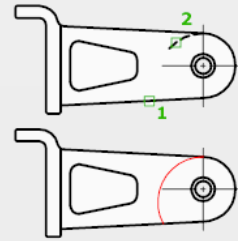

Para o comando Extend prolongar as linhas até à intersecção: alterar o parâmetro edgemode de 0 para 1

AULA 2 Desenho Técnico Assistido por Computador

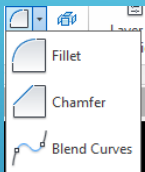

Fillet

Rounds and fillets the edges of objects

In the example, an arc is created that is tangent to both of the selected lines. The lines are trimmed to the ends of the arc. To create a sharp corner instead, enter a radius of zero.

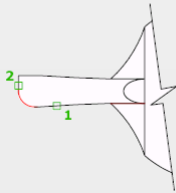

Chamfer

Bevels the edges of objects

The distances and angles that you specify are applied in the order that you select the objects.

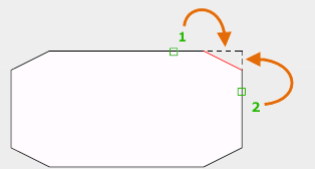

Blend Curves

Creates a tangent or smooth spline between the endpoints of two open curves

Select each object near an endpoint. The shape of the resulting spline depends on the specified continuity. The lengths of the selected objects remain unchanged.



AULA 2 Desenho Técnico Assistido por Computador

Offset

Creates concentric circles, parallel lines, and parallel curves

You can offset an object at a specified distance or through a point. After you offset objects, you can trim and extend them as an efficient method to create drawings containing many parallel lines and curves.

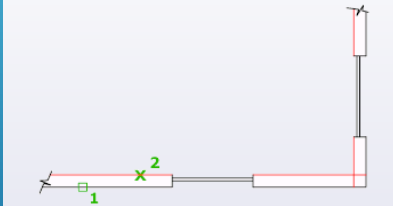

Explode

Breaks a compound object into its component objects

Explodes a compound object when you want to modify its components separately. Objects that can be exploded include blocks, polylines, and regions, among others.

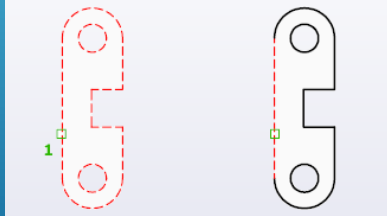

Erase

Removes objects from a drawing

Instead of selecting objects to erase, you can enter an option, such as **L** to erase the last object drawn, **P** to erase the previous selection set, or **ALL** to erase all objects. You can also enter **?** to get a list of all options.

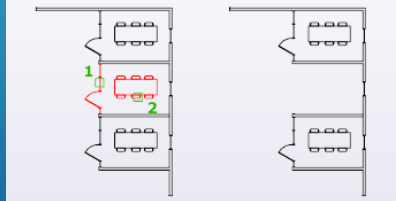

AULA 2 Desenho Técnico Assistido por Computador

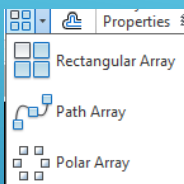

Rectangular Array

Distributes object copies into any combination of rows, columns, and levels.

Creates an array of rows and columns of copies of the selected object.

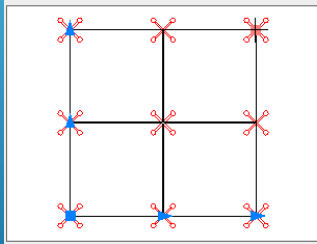

Path Array

Evenly distributes object copies along a path or a portion of a path.

The path can be a line, polyline, 3D polyline, spline, helix, arc, circle, or ellipse.

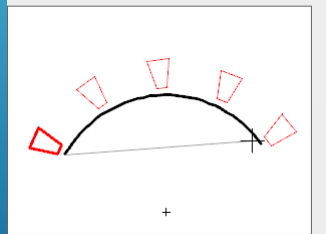

Polar Array

Evenly distributes object copies in a circular pattern around a center point or axis of rotation.

Creates an array by copying the selected objects around a specified center point or axis of rotation.

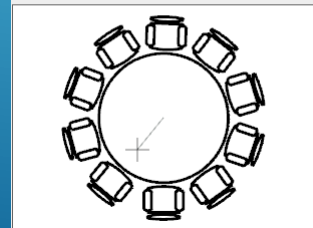

AULA 2 Desenho Técnico Assistido por Computador

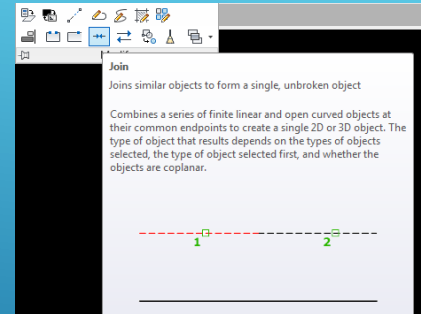
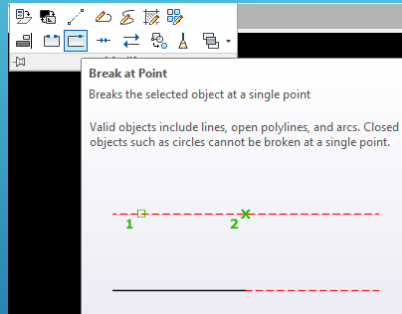
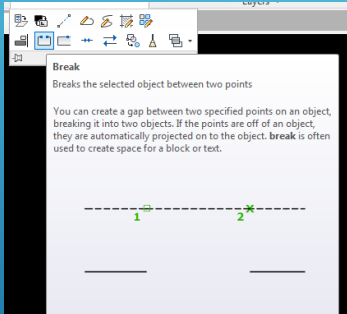

AULA 2 Desenho Técnico Assistido por Computador

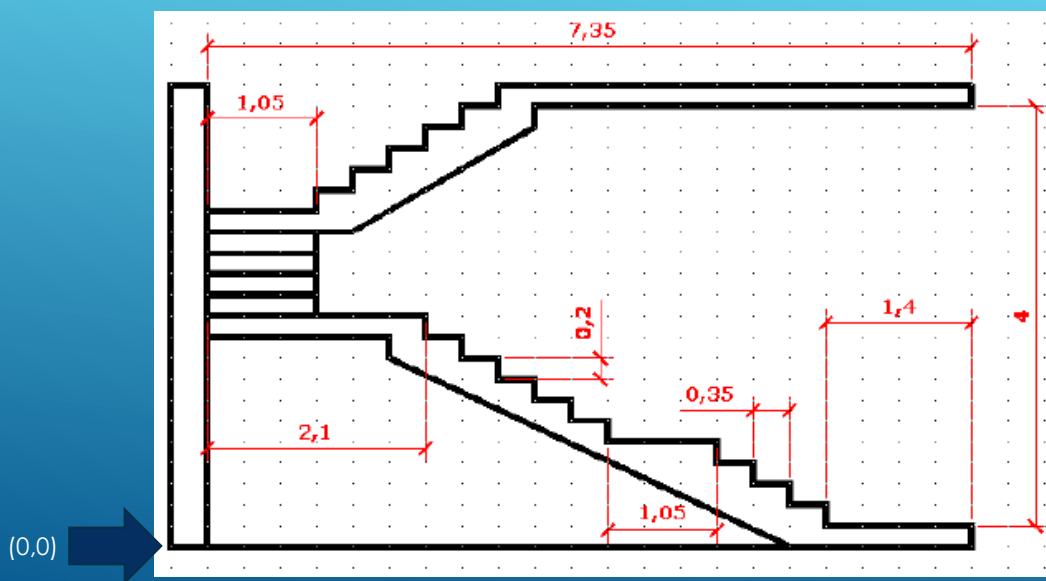

AULA 2 Desenho Técnico Assistido por Computador

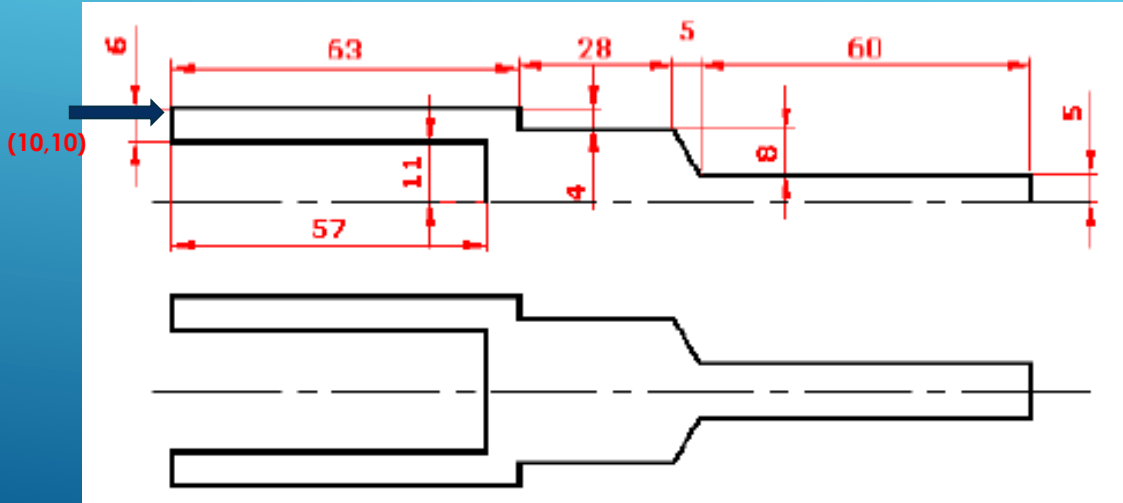

AULA 2 Desenho Técnico Assistido por Computador

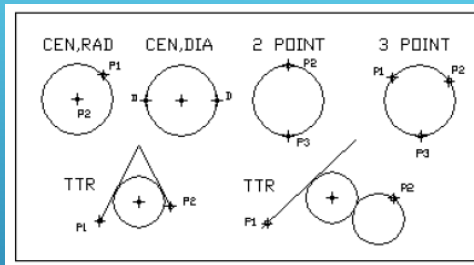

Linha de comando:
 LINE <enter>
 TAN <enter>
 Seleccionar ponto na 1ª circunferência
 TAN <enter>
 Seleccionar ponto na 2ª circunferência

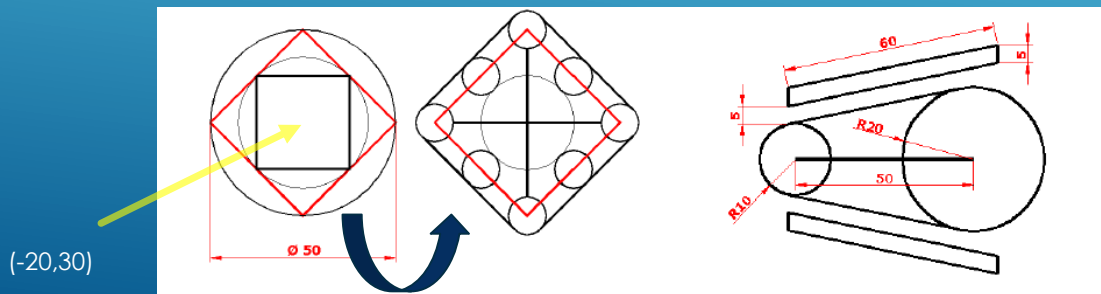

(-20,30)

AULA 2 Desenho Técnico Assistido por Computador

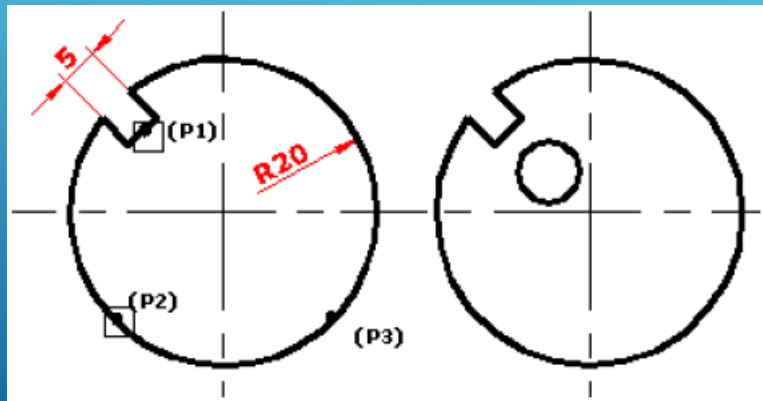
 Ciências
 ULisboa | Engenharia Geográfica,
 Geofísica e Energia

AULA 2 Desenho Técnico Assistido por Computador

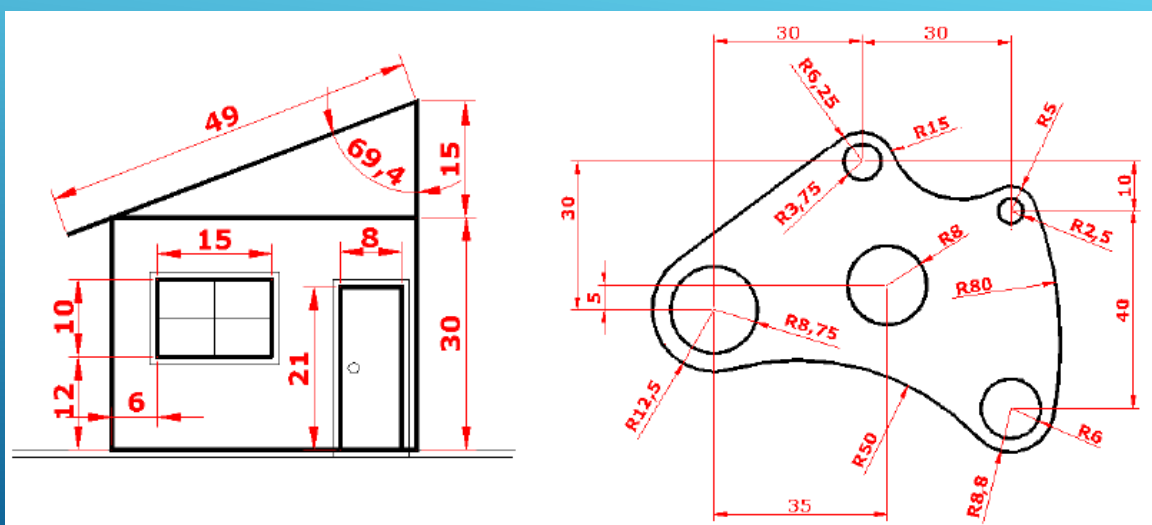
 Ciências
 ULisboa | Engenharia Geográfica,
 Geofísica e Energia

AULA 2 Desenho Técnico Assistido por Computador

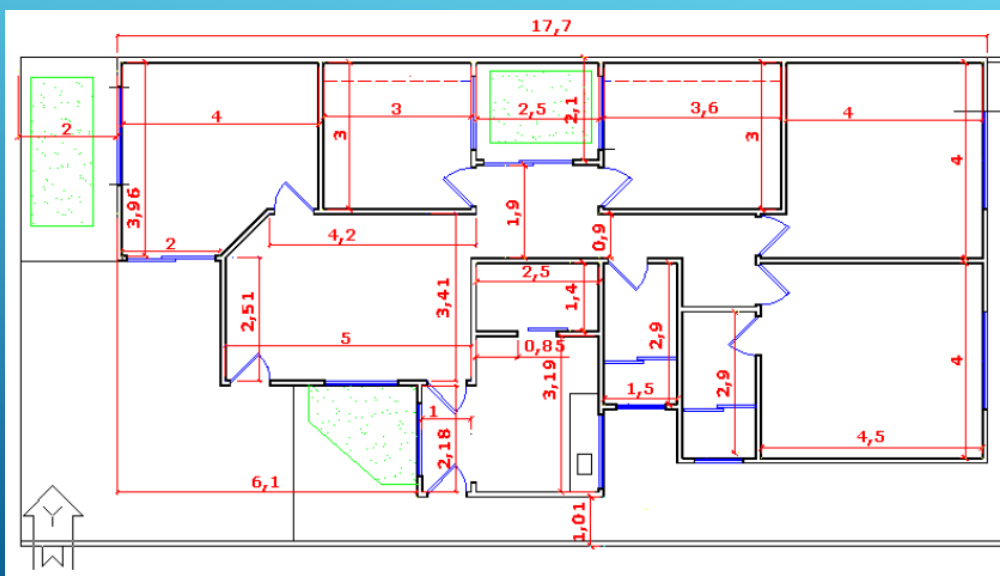

AULA 2 Desenho Técnico Assistido por Computador

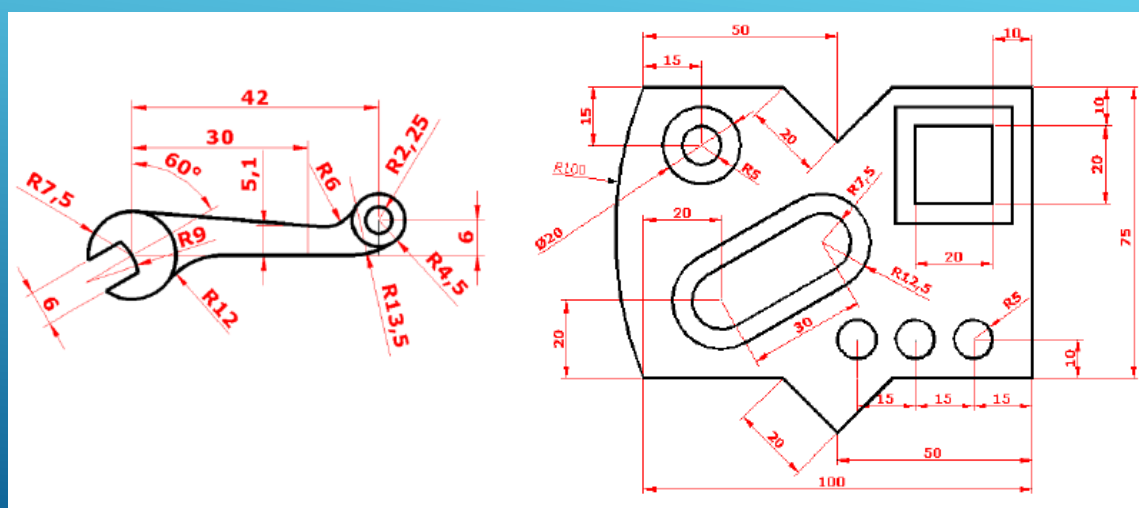

AULA 2 Desenho Técnico Assistido por Computador

